



LM4863

CMOS IC

DUAL 2.2W AUDIO AMPLIFIER PLUS STEREO HEADPHONE FUNCTION

DESCRIPTION

The UTC **LM4863** is a dual bridge-connected audio power amplifier. It combines dual bridge speaker amplifiers and stereo headphone amplifiers on one chip to simplify audio system design. In addition, the headphone input pin allows the amplifiers to operate in single-ended mode when driving stereo headphones.

The IC could deliver different power by packages as below (when connected to a 5V supply with less than 1.0% THD+N.):

- HTSSOP-20, 4Ω load: 2.2W
- HTSSOP-20, 3Ω load: 2.5W(with forced-air cooled)
- SOP/DIP , 8Ω load: 1.1W.

The UTC **LM4863** features an externally controlled, low-power consumption shutdown mode, a stereo headphone amplifier mode, and thermal shutdown protection. It also utilizes circuitry to reduce "clicks and pops" during device turn-on.

FEATURES

- * "Click and pop" suppression circuitry
- * Thermal shutdown protection circuitry
- * Unity-gain stable
- * Stereo headphone amplifier mode

ORDERING INFORMATION

Ordering Number		Package	Packing
Normal	Lead Free Plating		
LM4863-D16-T	LM4863L-D16-T	DIP-16	Tube
LM4863-S18-R	LM4863L-S18-R	SOP-18	Tape Reel
LM4863-S18-T	LM4863L-S18-T	SOP-18	Tube
LM4863-N20-R	LM4863L-N20-R	HTSSOP-20	Tape Reel
LM4863-N20-T	LM4863L-N20-T	HTSSOP-20	Tube

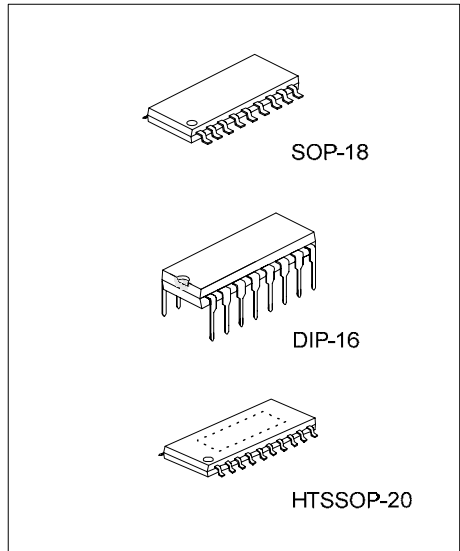

*Pb-free plating product number: LM4863L

<p>LM4863L-D16-T</p> <p>(1) Packing Type (2) Package Type (3) Lead Plating</p>	<p>(1) R: Tape Reel, T: Tube (2) D16: DIP-16, S18: SOP-18, N20: HTSSOP-20 (3) L: Lead Free Plating, Blank: Pb/Sn</p>
--	--

PIN CONFIGURATION

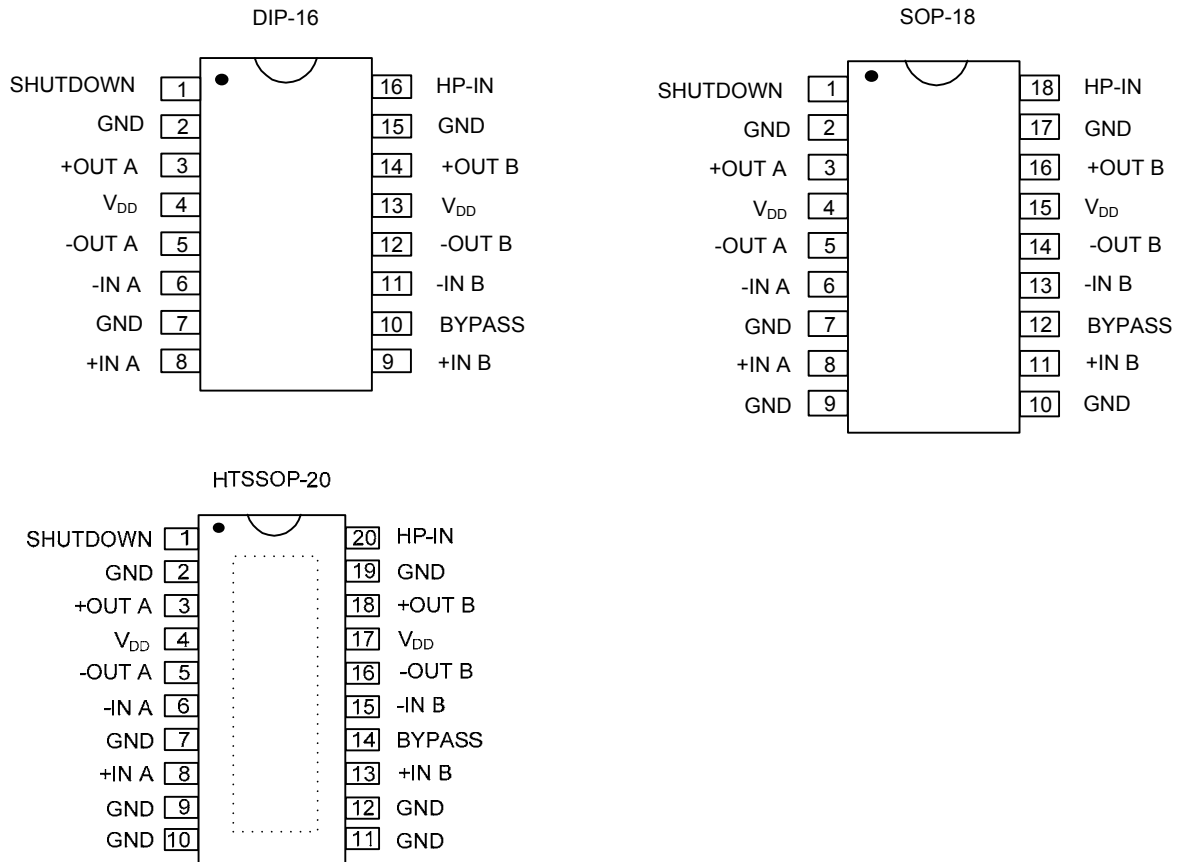

PIN DESCRIPTION

PIN NO.			PIN NAME	I/O	PIN DESCRIPTION
DIP-16	SOP-18	HTSSOP-20			
4,13	4,15	4,17	V _{DD}	-	Supply voltage
2,7,15	2,7,9,10,17	2,7,9,10,11,12,19	GND	-	Ground
10	12	14	BYPASS	-	Internal mid-supply bias reference bypassing
1	1	1	SHUTDOWN	I	Entire IC into the shutdown mode when this pin connected to the V _{DD}
16	18	20	HP-IN	I	Output mode select, connected to the V _{DD} for SE mode or GND for BTL mode
8	8	8	+INA	I	Non-inverting input of channel A, connected to BYPASS pin inside the IC
6	6	6	-INA	I	Inverting input of channel A
3	3	3	+OUTA	O	Channel A + output in BTL mode, high impedance in SE mode
5	5	5	-OUTA	O	Channel A - output in BTL mode, + output in SE mode
9	11	13	+INB	I	Non-inverting input of channel B, connected to BYPASS pin inside the IC
11	13	15	-INB	I	Inverting input of channel B
14	16	18	+OUTB	O	Channel B + output in BTL mode, high impedance in SE mode
12	14	16	-OUTB	O	Channel B - output in BTL mode, + output in SE mode

■ ABSOLUTE MAXIMUM RATINGS

PARAMETER	SYMBOL	RATINGS	UNIT
Supply Voltage	V _{DD}	6.0	V
Recommended Supply Voltage Range	V _{DD}	2.0 ~ 5.5	V
Input Voltage	V _{IN}	-0.3 ~ V _{DD} +0.3	V
Power Dissipation	P _D	Internally limited	
Junction Temperature	T _J	+125	
Operating Temperature	T _{OPR}	-40 ~ +85	
Storage Temperature	T _{STG}	-65 ~ +150	

Note Absolute maximum ratings are those values beyond which the device could be permanently damaged. Absolute maximum ratings are stress ratings only and functional device operation is not implied.

■ THERMAL DATA

PARAMETER	SYMBOL	RATINGS	UNIT
Thermal resistance (Junction to Ambient)	SOP-18	90	/W
	DIP-16	63	/W
	HTSSOP-20	90	/W
Thermal resistance (Junction to Case)	SOP-18	2	/W
	DIP-16	20	/W
	HTSSOP-20	2	/W

■ ELECTRICAL CHARACTERISTICS (Notes 1)(V_{DD}=5V, T_a=25 °C, unless otherwise specified)

PARAMETER	SYMBOL	TEST CONDITIONS	MIN	TYP	MAX	UNIT	
FOR ENTIRE IC							
Supply Voltage	V _{DD}		2		5.5	V	
Headphone Input Voltage	High	V _{IH}	4			V	
	Low	V _{IL}			0.8	V	
Quiescent Power Supply Current (Note 2)	I _{DD}	V _{IN} =0V, I _{OUT} =0A, HP-IN=0V	6	11.5	20	mA	
		V _{IN} =0V, I _{OUT} =0A, HP-IN=4V		5.8			
Shutdown Current	I _{SD}	V _{DD} applied to the SHUTDOWN pin	2	0.7		µA	
FOR BRIDGED-MODE OPERATION							
Output Offset Voltage	V _{O(OFF)}	V _{IN} =0V		5	50	mV	
Output Power (measured at the device terminals)	HTSSOP-20	P _{OUT}	THD=1%, f=1kHz	R _L =3Ω	2.5	W	
				R _L =4Ω	2.2		
	THD+N=10%, f=1kHz		R _L =3Ω	3.2	W		
			R _L =4Ω	2.7			
	SOP/DIP	P _{OUT}	THD=1%, f=1kHz	R _L =8Ω	1.0	1.1	W
				THD+N=10%, f=1kHz	R _L =8Ω		
THD+N=1%, f=1kHz, R _L =32Ω					0.34	W	
Total Harmonic Distortion + Noise	HTSSOP-20		THD+N	20Hz≤f≤20kHz, A _{VD} =2	R _L =4Ω, P _{OUT} =2W	0.3	%
	SOP/DIP	R _L =8Ω, P _{OUT} =1W			0.3		
Power Supply Rejection Ratio	PSRR	V _{DD} =5V, V _{RIPPLE} =200mV _{RMS} , R _L =8Ω, C _B =1.0µF		67		dB	
Channel Separation	X _{TALK}	f=1kHz, C _B =1.0µF		90		dB	
Signal To Noise Ratio	SNR	V _{DD} =5V, P _{OUT} =1.1W, R _L =8Ω		98		dB	

■ ELECTRICAL CHARACTERISTICS(Cont.)

PARAMETER	SYMBOL	TEST CONDITIONS	MIM	TYP	MAX	UNIT
FOR SINGLE-ENDED OPERATION						
Output Offset Voltage	$V_{O(OFF)}$	$V_{IN}=0V$		5	50	mV
Output Power	P_{OUT}	THD=0.5%, f=1kHz, $R_L=32\Omega$	75	85		mW
		THD+N=1%, f=1kHz, $R_L=8\Omega$		340		
		THD+N=10%, f=1kHz, $R_L=8\Omega$		440		
Total Harmonic Distortion + Noise	THD+N	$A_V=-1$, $P_{OUT}=75mW$, $20Hz \leq f \leq 20kHz$, $R_L=32\Omega$		0.2		%
Power Supply Rejection Ratio	PSRR	$C_B=1.0\mu F$, $V_{RIPPLE}=200mV_{RMS}$, f=1kHz		52		dB
Channel Separation	X_{TALK}	f=1kHz, $C_B=1.0\mu F$		60		dB
Signal To Noise Ratio	SNR	$V_{DD}=5V$, $P_{OUT}=340mW$, $R_L=8\Omega$		95		dB

Note: 1. All voltages are measured with respect to the ground (GND) pins, unless otherwise specified.

2. Depends on the offset voltage when a practical load is connected to the amplifier.

3. When driving 3Ω or 4Ω and operating on a 5V supply, the HTSSOP-20 package must be mounted to the circuit board that has a minimum of 2.5 in² of exposed, uninterrupted copper area connected to the exposed-DAP.

■ TYPICAL APPLICATION CIRCUIT

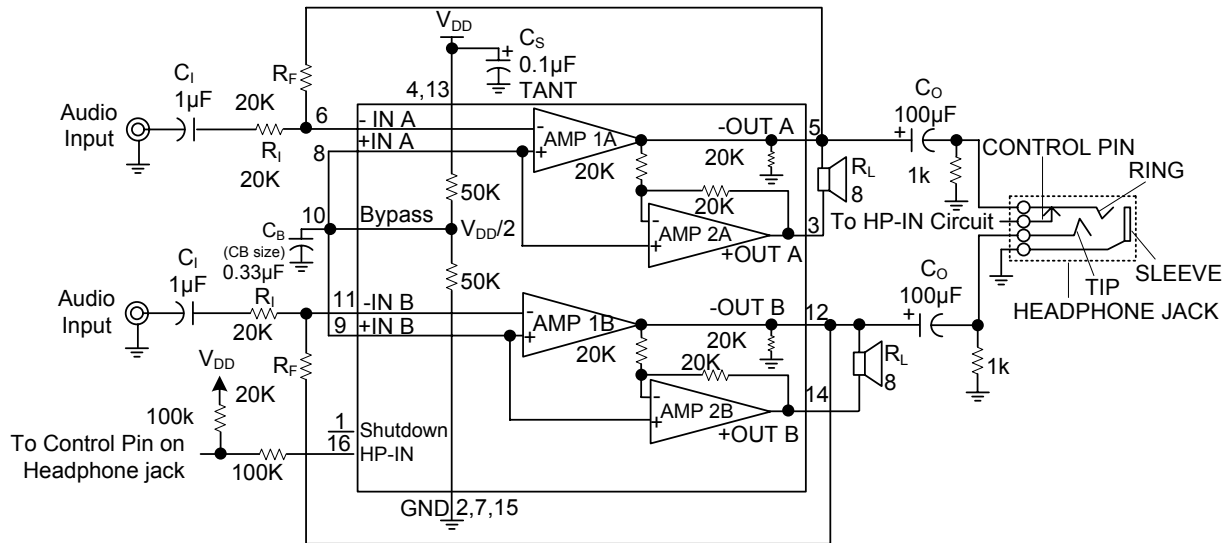

Note: Pin out shown for DIP-16. Refer to the PIN CONFIGURATION for the pin out of other packages.

Figure 1. Typical Audio Amplifier Application Circuit

■ EXTERNAL COMPONENTS DESCRIPTION

Components	Functional Description
R _I	The inverting input resistance, along with R _F , set the closed-loop gain. R _I , along with C _I form a high pass filter with $f_c=1/(2 R_I C_I)$
C _I	The input coupling capacitor blocks DC voltage at the amplifier's input terminals. C _I , along with R _I , create a high pass filter with $f_c=1/(2 R_I C_I)$. Refer to the section. Selecting Proper External Components, for an explanation of determine the value of C _I .
R _F	The feedback resistance, along with R _I , set the closed-loop gain.
C _S	The supply bypass capacitor. Refer to the Power Supply Bypassing section for information about properly placing and selecting the value of, this capacitor.
C _B	The capacitor, C _B , filters the half-supply voltage present on the Bypass pin. Refer to the Selecting Proper External Components section for information concerning proper placement and selecting C _B 'S value.

TYPICAL CHARACTERISTICS

(For HTSSOP-20)

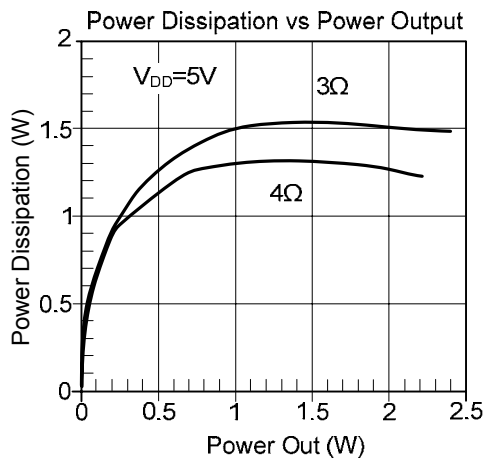
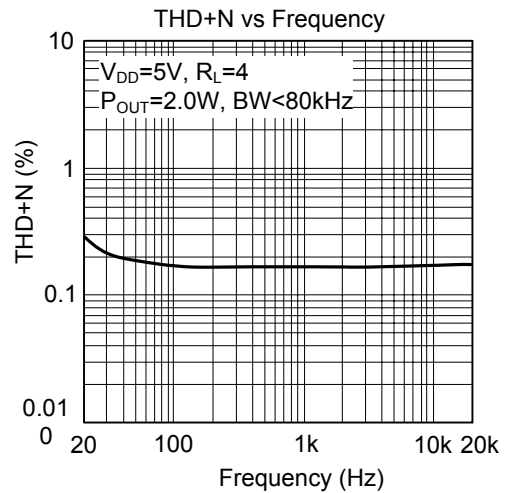
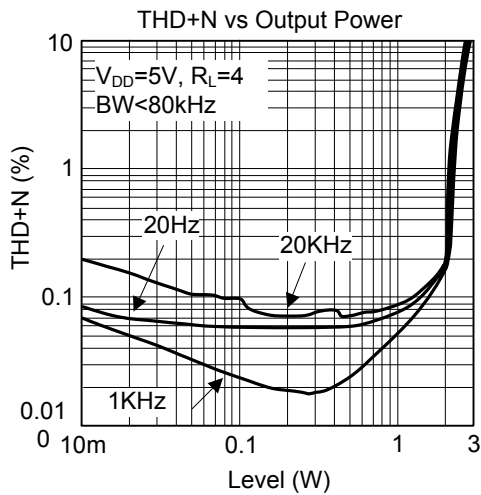
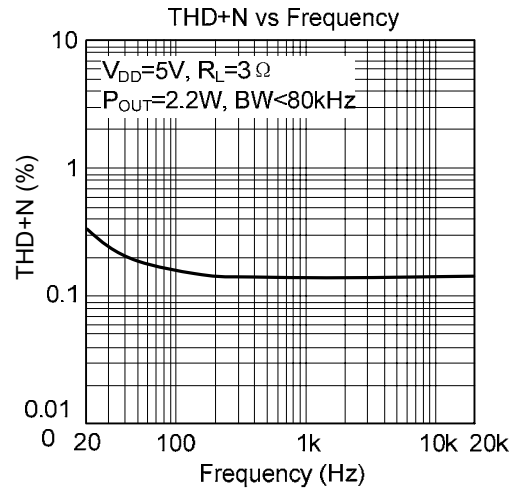
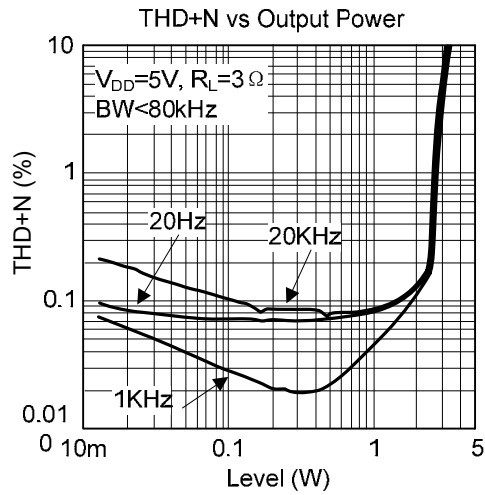

■ TYPICAL CHARACTERISTICS(Cont.)

(For DIP-16 and SOP-18)

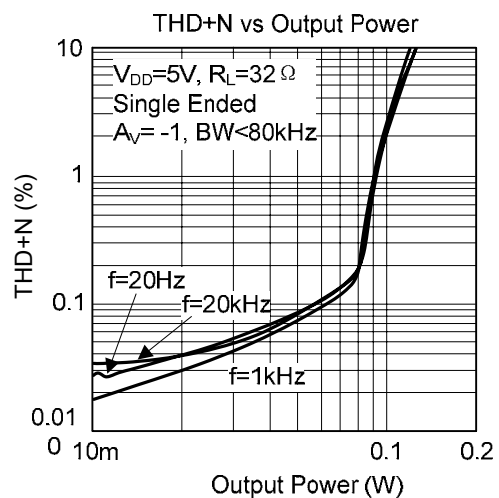
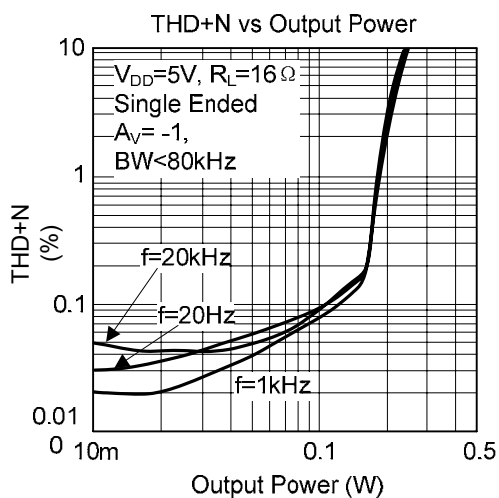
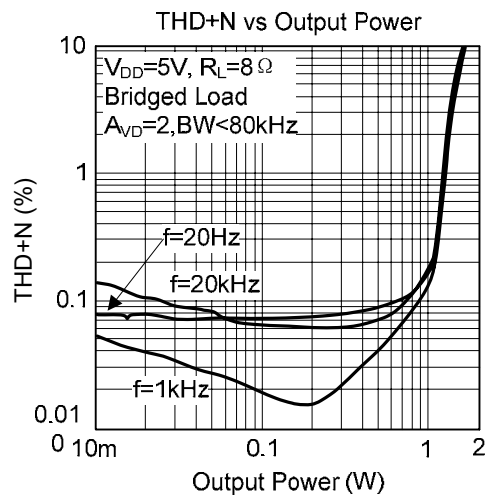
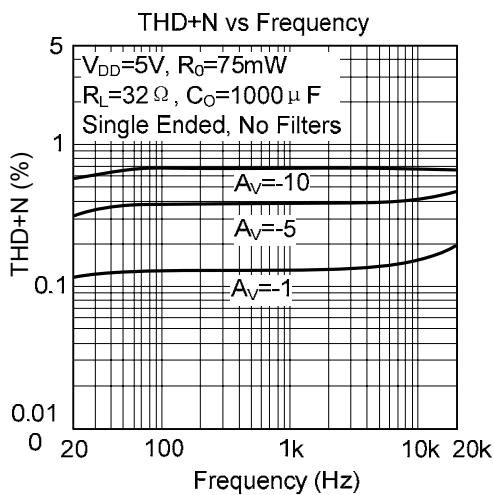
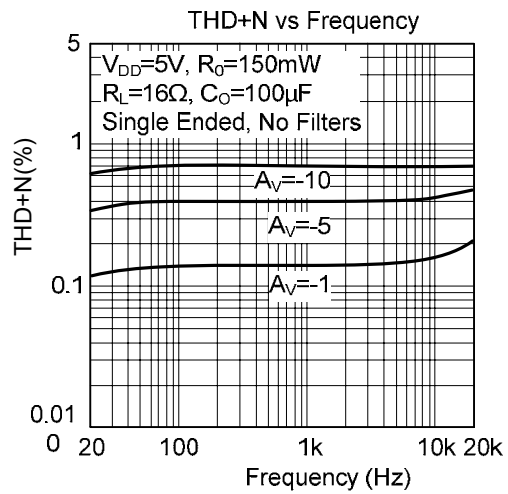
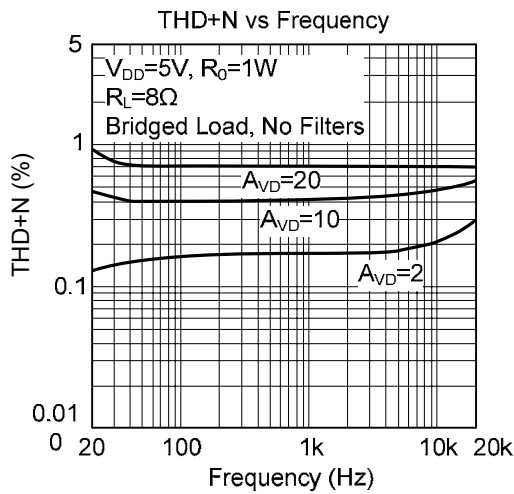

TYPICAL CHARACTERISTICS(Cont.)

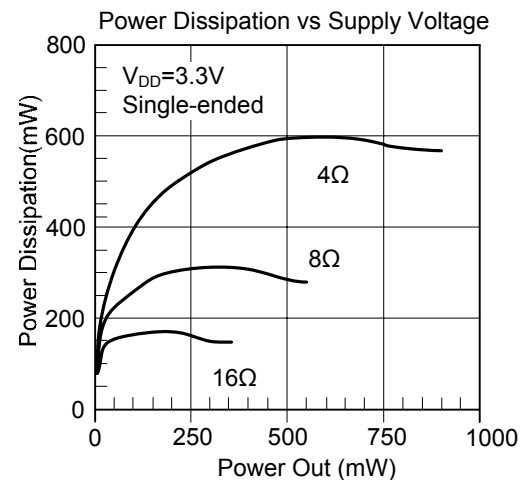
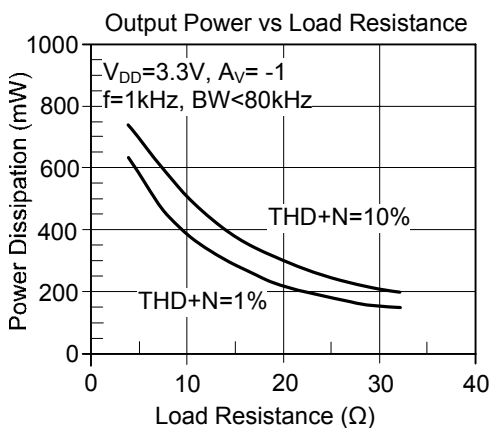
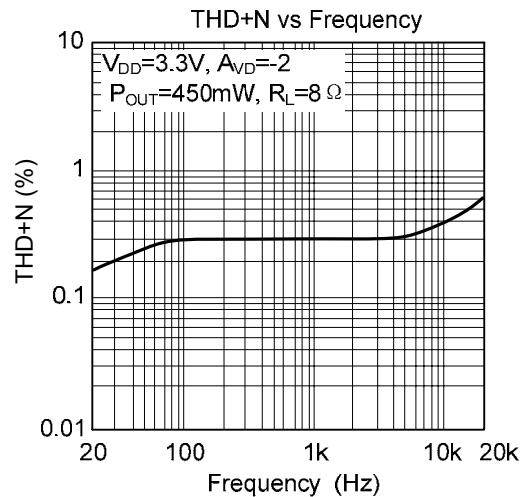
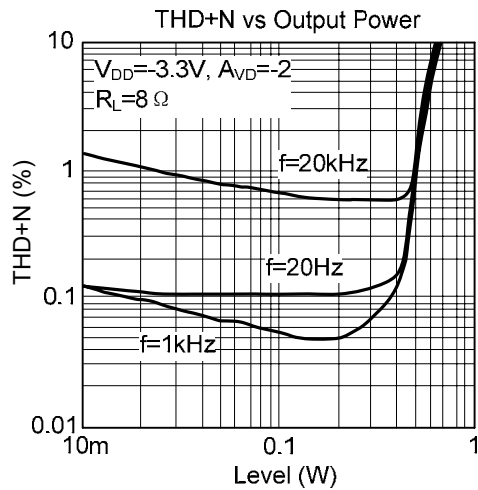
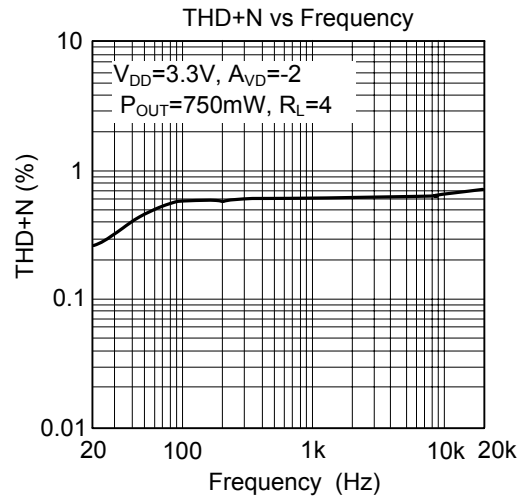
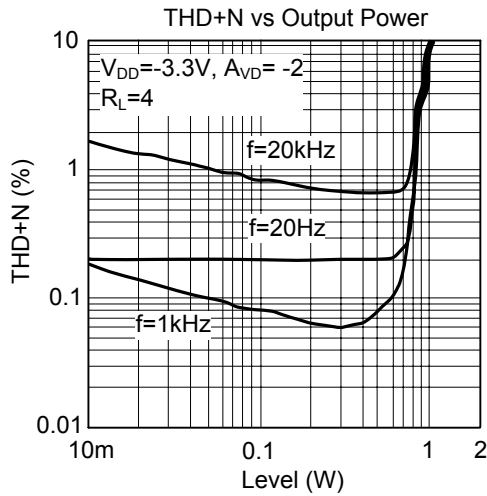

TYPICAL CHARACTERISTICS(Cont.)

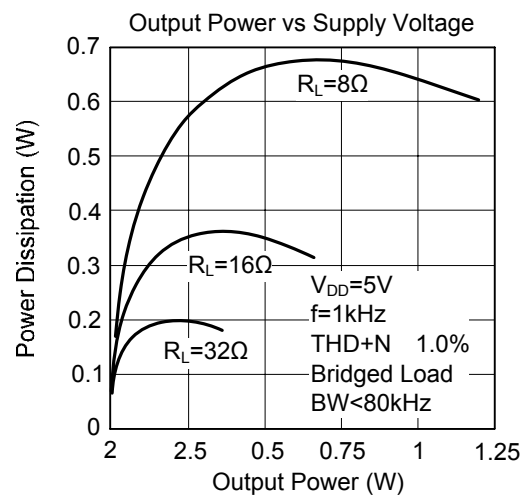
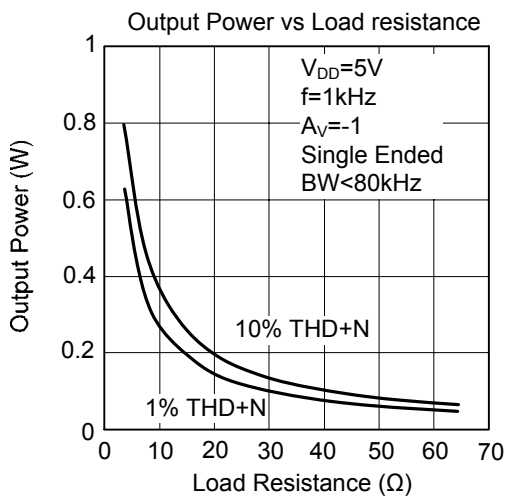
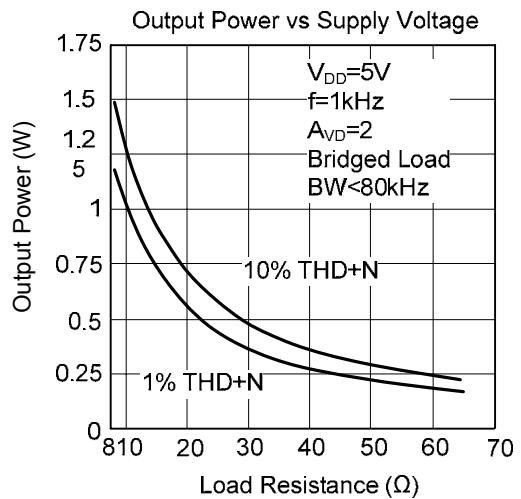
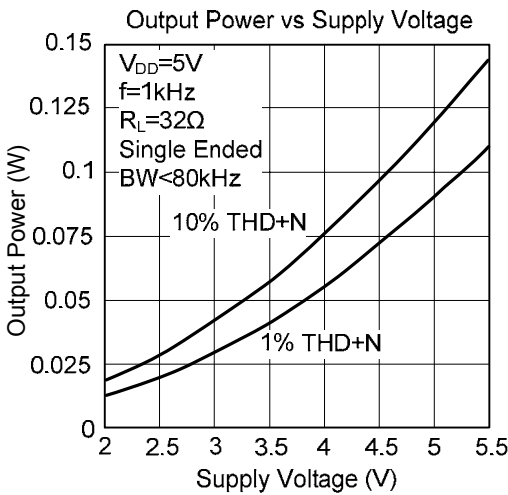
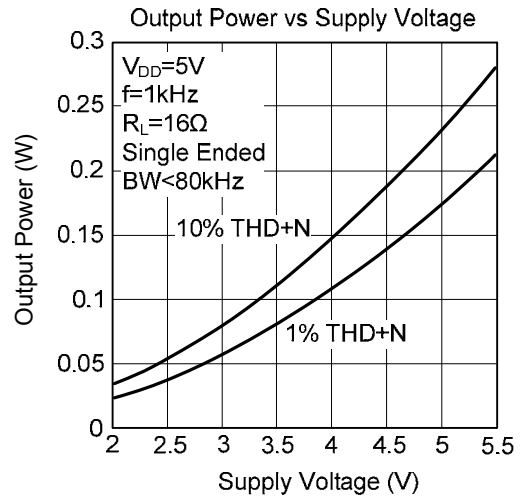
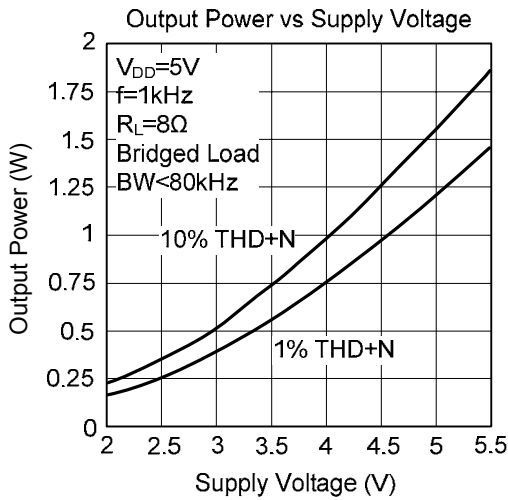

TYPICAL CHARACTERISTICS(Cont.)

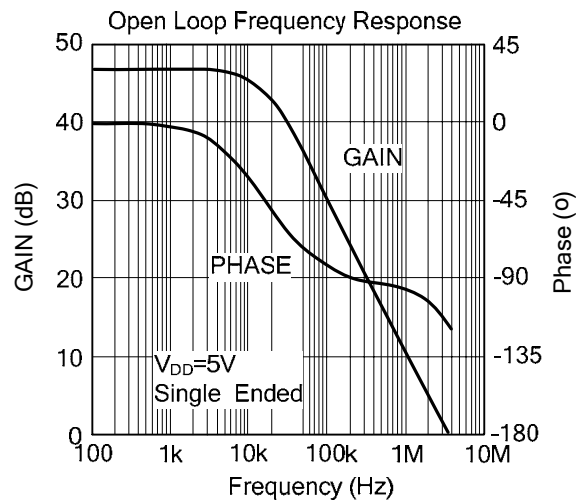
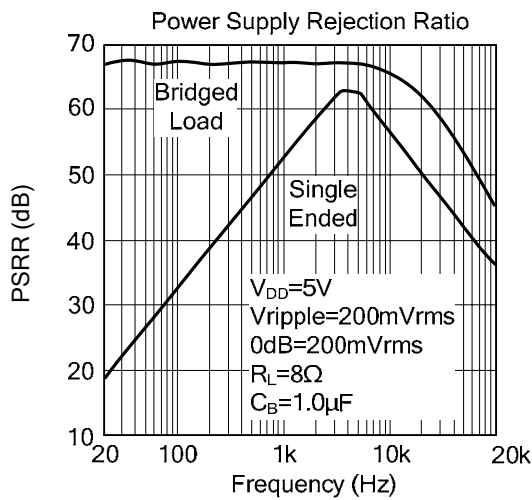
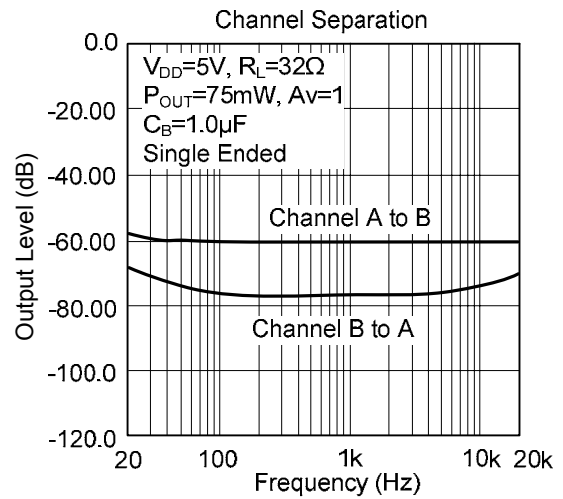
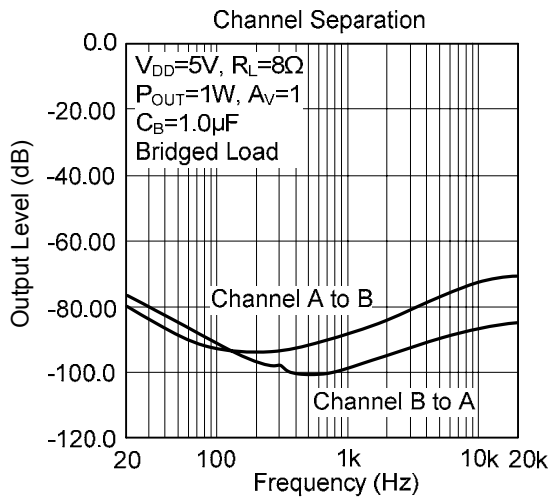
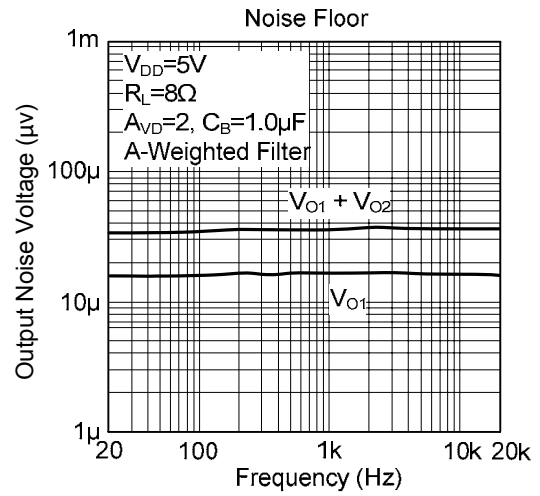
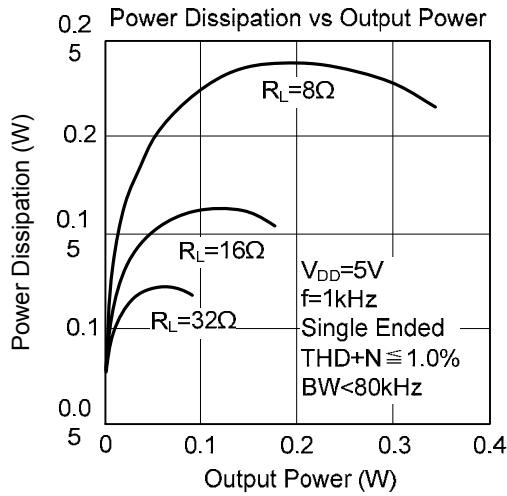

■ TYPICAL CHARACTERISTICS(Cont.)

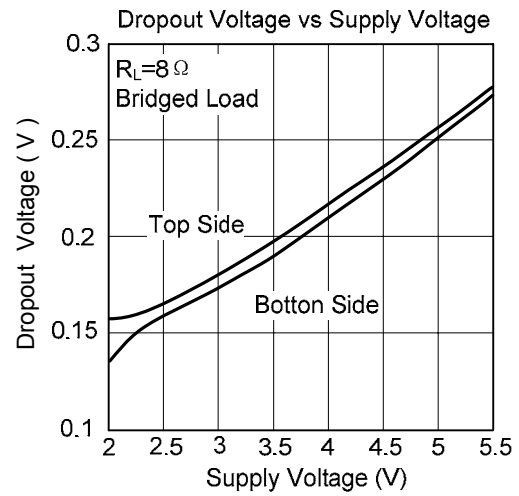
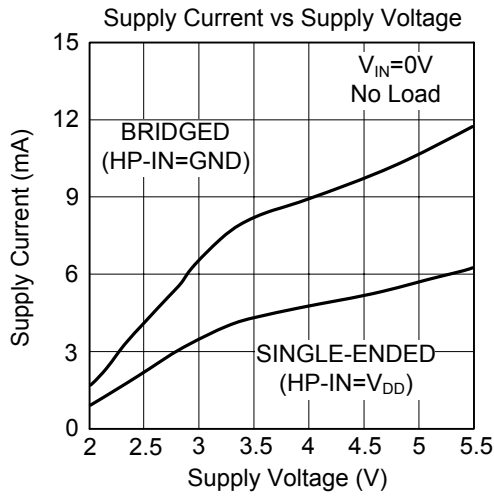

UTC assumes no responsibility for equipment failures that result from using products at values that exceed, even momentarily, rated values (such as maximum ratings, operating condition ranges, or other parameters) listed in products specifications of any and all UTC products described or contained herein. UTC products are not designed for use in life support appliances, devices or systems where malfunction of these products can be reasonably expected to result in personal injury. Reproduction in whole or in part is prohibited without the prior written consent of the copyright owner. The information presented in this document does not form part of any quotation or contract, is believed to be accurate and reliable and may be changed without notice.